

# Meeting Rooms and Configurations

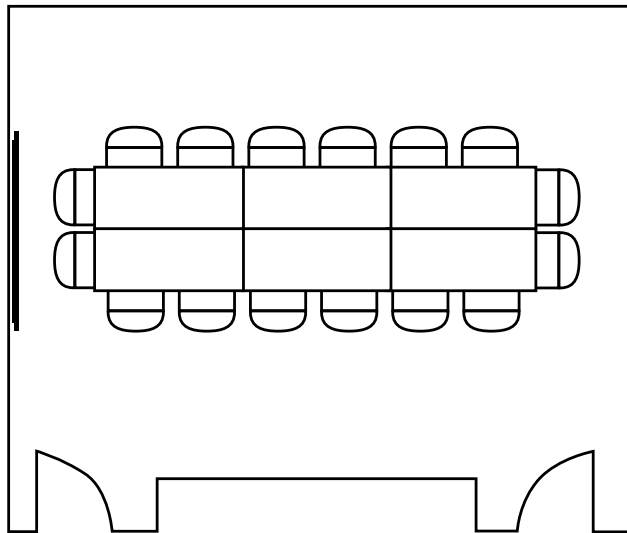

1801 Alexander Bell Drive  
Reston, VA 20191-4400  
(703) 295-6167

# DMJM



**BOARDROOM**  
16 PPL

## Additional Room Configurations

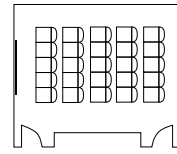

**THEATER**  
25 PPL

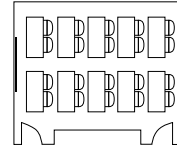

**CLASSROOM**  
20 PPL

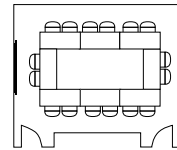

**HOLLOW SQUARE**  
16 PPL

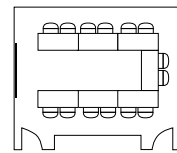

**U SHAPE**  
14 PPL

## DJMJ Room Features

- Wireless Internet Connectivity
- A/V Equipment
- Mitel Teleconference System
- Zoned Lighting Options
- Fully Automated Sunshades and Blackout Blinds
- Flipchart with Markers
- Sustainable Practices in Keeping with LEED Standards
- 70" LED Flat Screen Monitor
- WePresent Wireless Presentation

## Additional Meeting Services

**Hungry?** Don't forget about your catering and beverage service needs.

# Harris

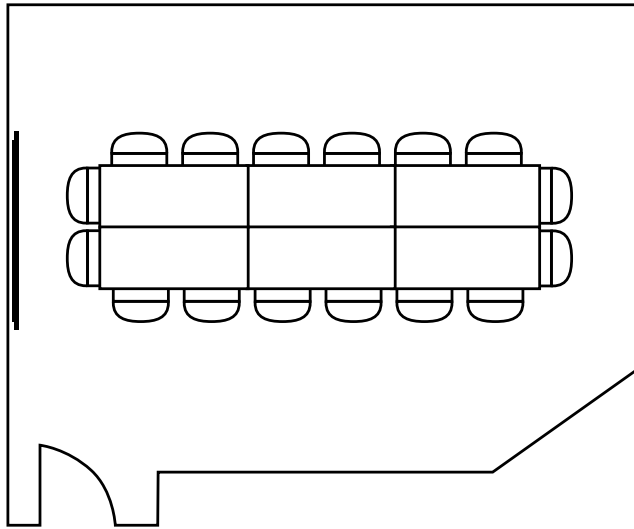

**BOARDROOM**  
16 PPL

SIZE  
432 SF

MAX CAPACITY  
25

RECOMMENDED  
4-20

## Additional Room Configurations

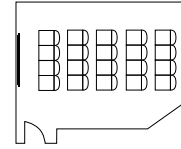

**THEATER**  
20 PPL

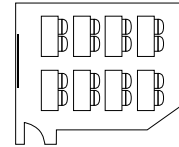

**CLASSROOM**  
16 PPL

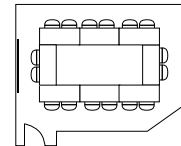

**HOLLOW SQUARE**  
16 PPL

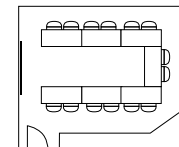

**U SHAPE**  
14 PPL

## Harris Room Features

- Wireless Internet Connectivity
- A/V Equipment
- Mitel Teleconference System
- Zoned Lighting Options
- Fully Automated Sunshades and Blackout Blinds
- Flipchart with Markers
- Sustainable practices in keeping with LEED Standards
- 70" LED Flat Screen Monitor
- WePresent Wireless Presentation

## Additional Meeting Services

**Hungry?** Don't forget about your catering and beverage service needs.

# CH2M Hill (A)

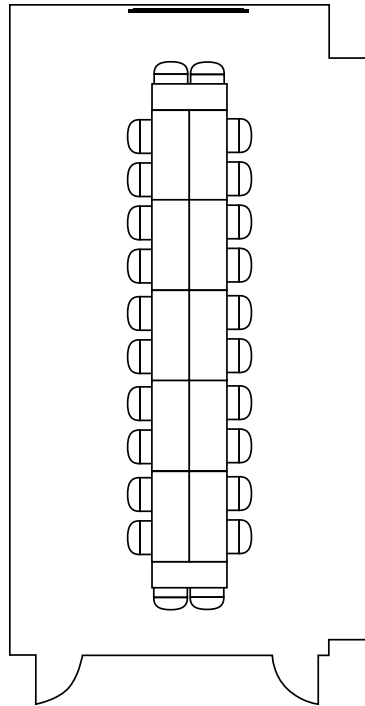

**BOARDROOM**  
24 PPL

SIZE  
924 SF

MAX CAPACITY  
54

RECOMMENDED  
15-50

## Additional Room Configurations

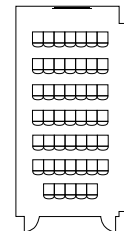

**THEATER**  
54 PPL

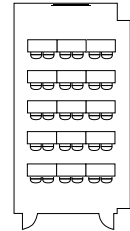

**CLASSROOM**  
30 PPL

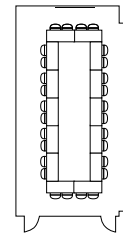

**HOLLOW SQ.**  
28 PPL

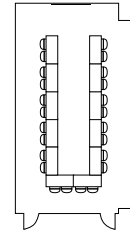

**U SHAPE**  
24 PPL



**STANDING RECEPTION**  
35 PPL

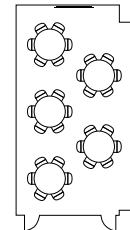

**ROUNDS**  
30 PPL

## CH2M Hill Features

- Wireless Internet Connectivity
- A/V Equipment
- Mitel Teleconference System
- Zoned Lighting Options
- Fully Automated Sunshades and Blackout Blinds
- Flipchart with Markers
- Sustainable practices in keeping with LEED Standards
- 90" LED Flat Screen Monitor
- WePresent Wireless Presentation

## Additional Meeting Services

**Hungry?** Don't forget about your catering and beverage service needs.

# ASCE (B)

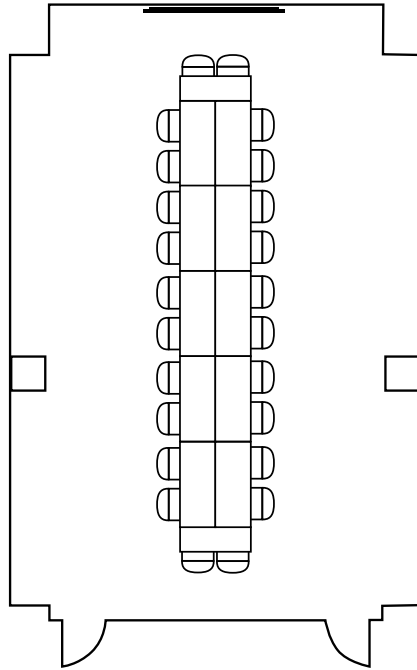

**BOARDROOM**  
24 PPL

## Additional Room Configurations

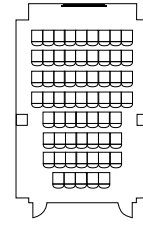

**THEATER**  
78 PPL

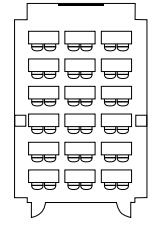

**CLASSROOM**  
36 PPL

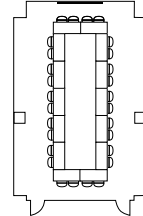

**HOLLOW SQ.**  
28 PPL

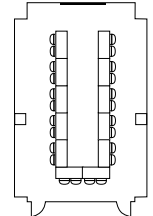

**U SHAPE**  
24 PPL

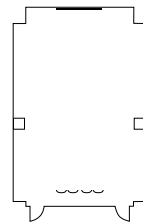

**STANDING RECEPTION**  
40 PPL

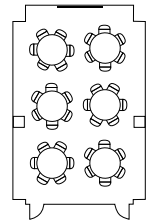

**ROUNDS**  
36 PPL

## ASCE Features

- Wireless Internet Connectivity
- A/V Equipment
- Mitel Teleconference System
- Zoned Lighting Options
- Fully Automated Sunshades and Blackout Blinds
- Flipchart with Markers
- Sustainable practices in keeping with LEED Standards
- 90" LED Flat Screen Monitor
- WePresent Wireless Presentation

SIZE  
1,218 SF

MAX CAPACITY  
78

RECOMMENDED  
24-73

## Additional Meeting Services

**Hungry?** Don't forget about your catering and beverage service needs.

# Seabury & Smith (C)

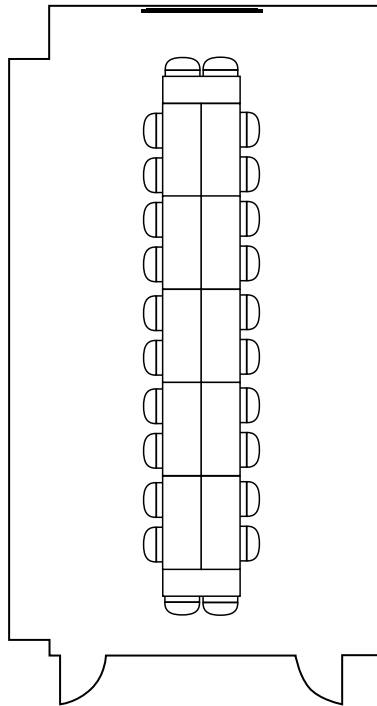

**BOARDROOM**  
26 PPL

SIZE  
924 SF

MAX CAPACITY  
54

RECOMMENDED  
15-50

## Additional Room Configurations

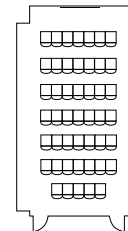

**THEATER**  
54 PPL

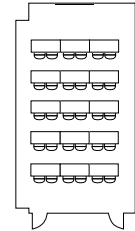

**CLASSROOM**  
30 PPL

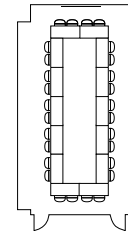

**HOLLOW SQ.**  
28 PPL

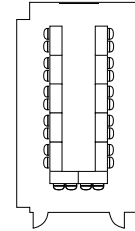

**U SHAPE**  
24 PPL

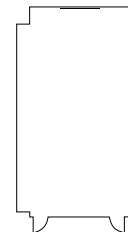

**STANDING RECEPTION**  
35 PPL

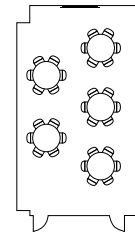

**ROUNDS**  
30 PPL

## Seabury & Smith Features

- Wireless Internet Connectivity
- A/V Equipment
- Mitel Teleconference System
- Zoned Lighting Options
- Fully Automated Sunshades and Blackout Blinds
- Flipchart with Markers
- Sustainable practices in keeping with LEED Standards
- 90" LED Flat Screen Monitor
- WePresent Wireless Presentation

## Additional Meeting Services

**Hungry?** Don't forget about your catering and beverage service needs.

# A&B Extended

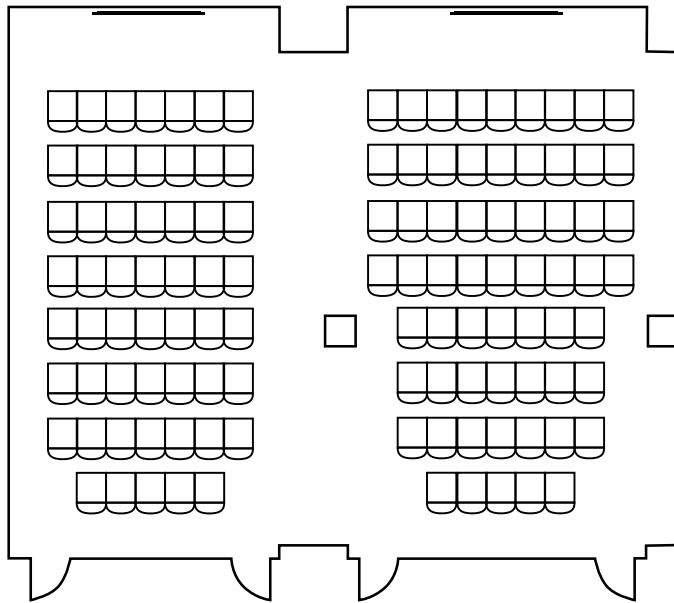

**THEATER**  
132 PPL

SIZE                      MAX CAPACITY                      RECOMMENDED  
2,142 SF                      80+/-                      70-130

## Additional Room Configurations

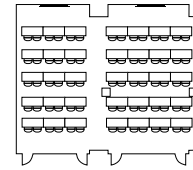

**CLASSROOM**  
70 PPL

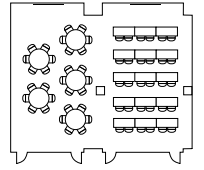

**CLASSROOM & ROUND**  
70 PPL

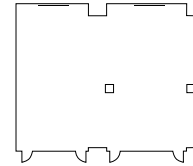

**STANDING RECEPTION**  
80 PPL

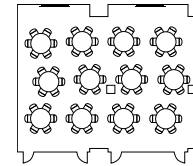

**ROUNDS**  
72 PPL

## A&B Extended Features

- Wireless Internet Connectivity
- A/V Equipment
- Mitel Teleconference System
- Zoned Lighting Options
- Fully Automated Sunshades and Blackout Blinds
- Flipchart with Markers
- Sustainable practices in keeping with LEED Standards
- 2 90" LED Flat Screen Monitors
- WePresent Wireless Presentation

## Additional Meeting Services

**Hungry?** Don't forget about your catering and beverage service needs.

# A,B&C Extended

## Meeting Room

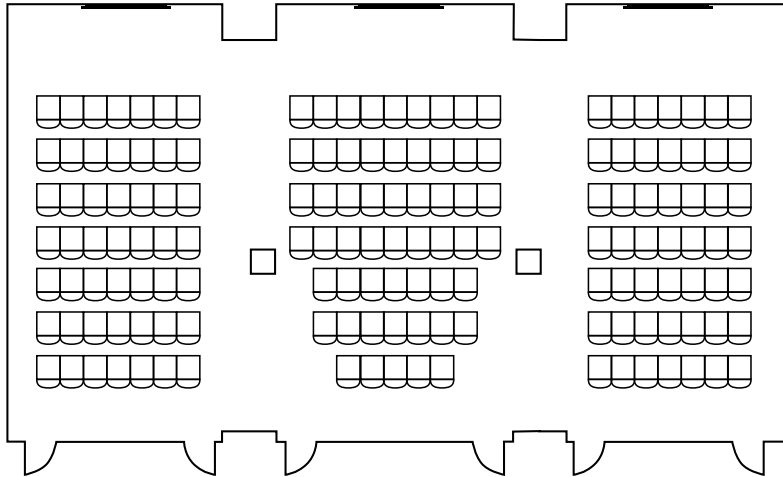

**THEATER**  
153 PPL

SIZE  
3,066 SF

MAX CAPACITY  
180+

RECOMMENDED  
90-150

## Additional Room Configurations

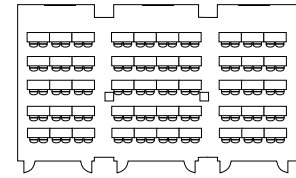

**CLASSROOM**  
104 PPL

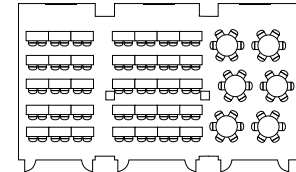

**CLASSROOM WITH ADJACENT ROUNDS**  
150 PPL

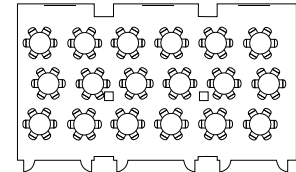

**ROUNDS**  
108 PPL

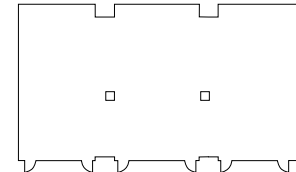

**RECEPTION**  
108 PPL

## A,B&C Extended Features

- Wireless Internet Connectivity
- A/V Equipment
- Mitel Teleconference System
- Zoned Lighting Options
- Fully Automated Sunshades and Blackout Blinds
- Flipchart with Markers
- Sustainable Practices in Keeping with LEED Standards
- 3 90" LCD Flat Screen Monitors
- WePresent Wireless Presentation

## Additional Meeting Services

**Hungry?** Don't forget about your catering and beverage service needs.

# Cardinal Room

## Meeting Room

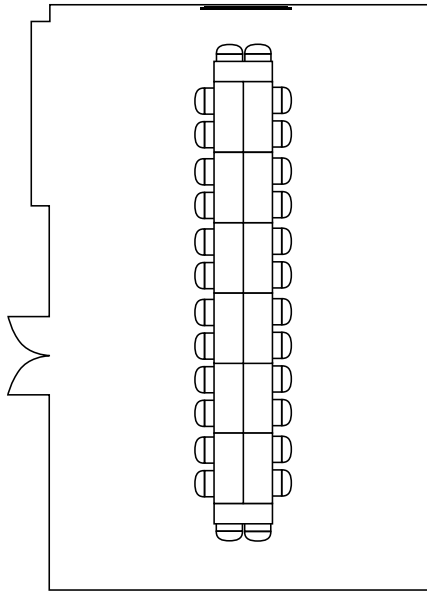

**BOARDROOM**  
28PPL

SIZE                      MAX CAPACITY                      RECOMMENDED  
1,250 SF                      72 ppl                      28-72 ppl

## Additional Room Configurations

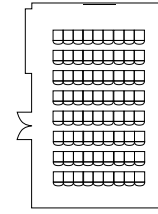

**THEATER**  
72 PPL

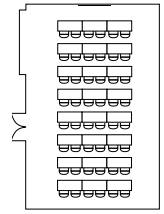

**CLASSROOM**  
48 PPL

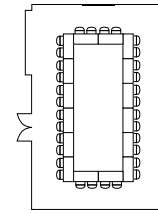

**HOLLOW SQ.**  
32 PPL

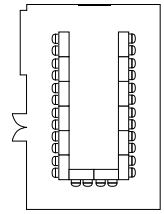

**U SHAPE**  
28 PPL

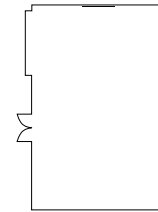

**STANDING RECEPTION**  
50 PPL

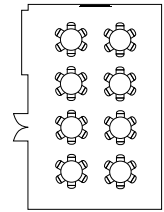

**ROUNDS**  
48 PPL

## Cardinal Room Features

- Wireless Internet Connectivity
- A/V Equipment
- Mitel Teleconference System
- Zoned Lighting Options
- Fully Automated Sunshades and Blackout Blinds
- Flipchart with Markers
- Sustainable practices in keeping with LEED Standards

## Additional Meeting Services

**Hungry?** Don't forget about your catering and beverage service needs.

1801 Alexander Bell Drive, Reston, VA 20191-4400  
(703) 295-6167 | [aportnoy@asce.org](mailto:aportnoy@asce.org)

**ASCE** | BECHTEL  
CONFERENCE  
CENTER

# Dulles Room

## Meeting Room

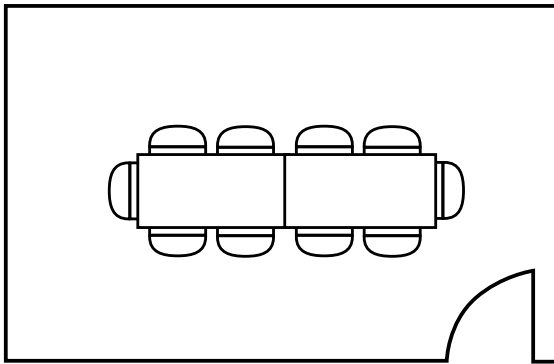

**BOARDROOM**  
10 PPL

SIZE  
250 SF

MAX CAPACITY  
14

RECOMMENDED  
2-10

## Additional Room Configurations

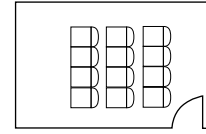

**THEATER**  
12 PPL

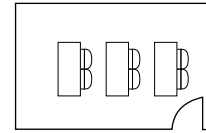

**CLASSROOM**  
6 PPL

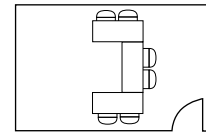

**U SHAPE**  
6 PPL

## Dulles Room Features

- Wireless Internet Connectivity
- A/V Equipment
- Mitel Teleconference System
- Zoned Lighting Options
- Fully Automated Sunshades and Blackout Blinds
- Flipchart with Markers
- Sustainable practices in keeping with LEED Standards
- Ceiling recessed drop-down projection screen
- Ceiling mounted projector

## Additional Meeting Services

**Hungry?** Don't forget about your catering and beverage service needs.

# Wadell Room

## Meeting Room

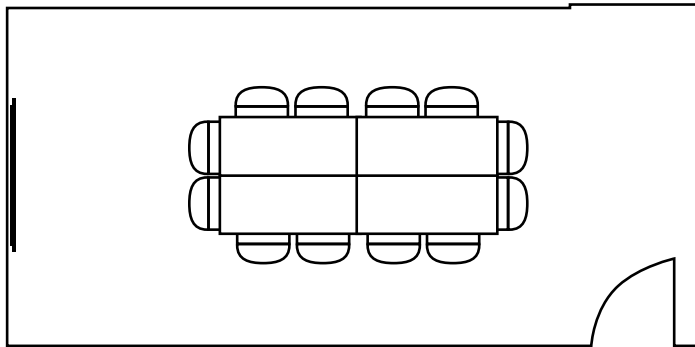

**BOARDROOM**  
12 PPL

## Additional Room Configurations

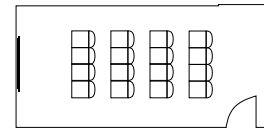

**THEATER**  
16 PPL

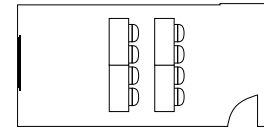

**CLASSROOM**  
8 PPL

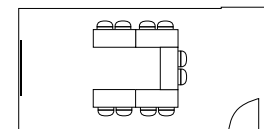

**U SHAPE**  
10 PPL

## Reston Room Features

- Wireless Internet Connectivity
- A/V Equipment
- Mitel Teleconference System
- Zoned Lighting Options
- Fully Automated Sunshades and Blackout Blinds
- Flipchart with Markers
- Sustainable practices in keeping with LEED Standards
- Ceiling recessed drop-down projection screen
- Ceiling mounted projector

SIZE  
325 SF

MAX CAPACITY  
14

RECOMMENDED  
2-12

## Additional Meeting Services

**Hungry?** Don't forget about your catering and beverage service needs.

# Chi Epsilon Room

## Meeting Room

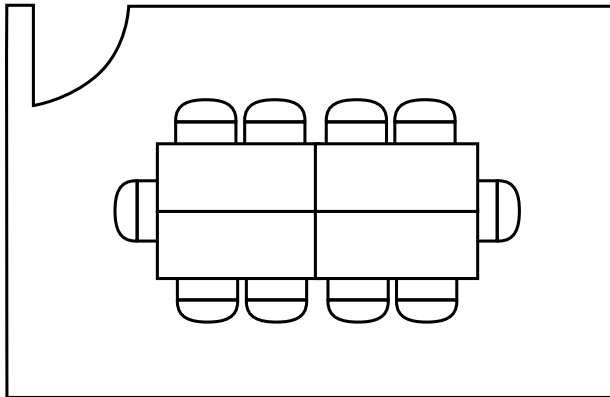

**BOARDROOM**  
10 PPL

## Chi Epsilon Room Features

- Wireless Internet Connectivity
- Mitel Teleconference System
- Zoned Lighting Options
- Flipchart with Markers
- Sustainable practices in keeping with LEED Standards

No food or drinks allowed in this room

SIZE  
300 SF

MAX CAPACITY  
14

RECOMMENDED  
2-12

## Additional Meeting Services

**Hungry?** Don't forget about your catering and beverage service needs.